

INSTALLATION INSTRUCTIONS

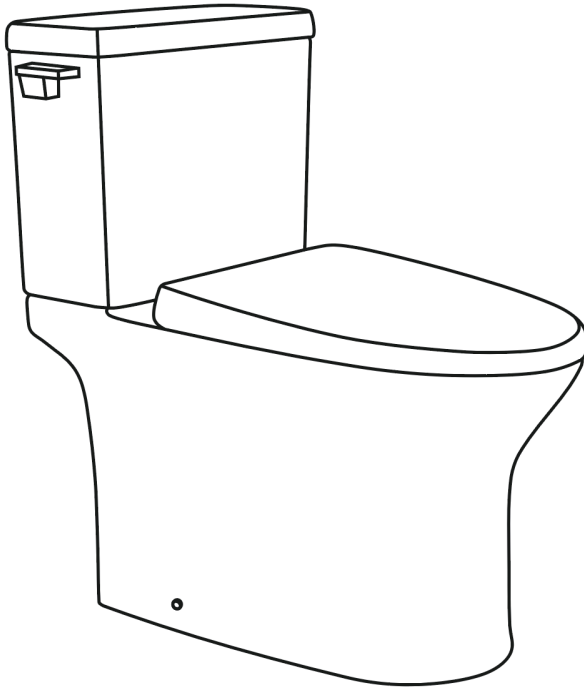

R5 Two-Piece Toilet



NOTE: Drawing may not exactly define the contour of the product.

cs@maceratingflo.com www.maceratingflo.com (+1) 626-670-9903

Prior To Installation

Hello, Home Improvement Hero!

As you prepare to install your MaceratingFlo Toilet, we're here to ensure you have a smooth and straightforward experience. Let's gear up to make your toilet installation a resounding success.

Before You Get Started:

- **Check Your Equipment:** Inspect your toilet right out of the box to ensure everything arrived in impeccable condition. We prioritize your satisfaction from the start!
- **Comply with Codes:** Adherence to state and local plumbing and building codes is a must. Keeping everything legal will provide peace of mind as you proceed.
- **Prepare the Space:** The foundation of a good install is a CLEAN and LEVEL mounting surface. This preparation is crucial for optimal operation and stability of your new system.
- **Team Effort:** For safety and ease, we recommend having a partner help you with the installation and moving of this product.
- **Handle with Care:** As you unpack and set up your MaceratingFlo products, remember they are FRAGILE GOODS. A gentle touch can prevent both breakage and injury.
- **Check Water Pressure:** Ensure that the water supply pressure is at a minimum of 35 PSI (2.5 kg/cm²). Your new toilet relies on this pressure to function correctly and efficiently.

Remember: The drawings are not to scale and are for illustrative purposes only. Check the detailed specifics at www.maceratingflo.com.

Need Help?

If any questions or concerns arise, we're here for you. Contact us at cs@maceratingflo.com or call (+1) 626-670-9903. We're committed to supporting you every step of the way.

Get Ready:

You're all set to transform your bathroom into a marvel of modernity and efficiency. Now, go ahead and install your MaceratingFlo like the pro you are!

Warm regards,
The MaceratingFlo Team

Manual
for R5 Macerating Toilet System



Installation Video
for R5 Macerating Toilet System



Note: For toilet-sewage pipe connection, skip pump installation and start viewing at 02:02 for reference.

SUGGESTED TOOLS AND MATERIALS (Not Provided)

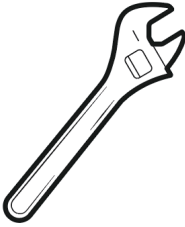

Wrench

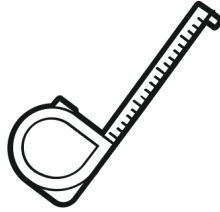

Tape Measure

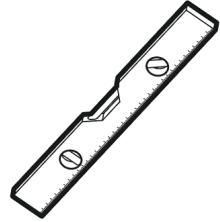

Level

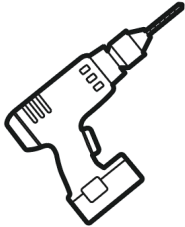

Drill

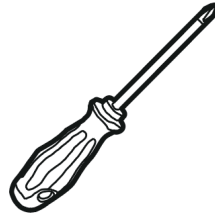

Cross Head
Screwdriver



Flat Head
Screwdriver



Pencil

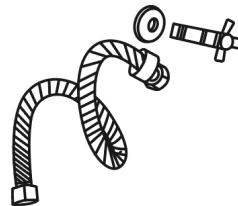

Water Supply Kit

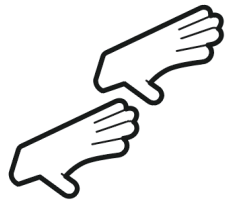

Cut Resistant Gloves

PARTS PROVIDED

Toilet Bowl

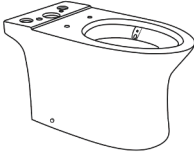

Toilet Bowl

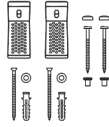

Toilet Bowl
Accessories

Water Tank

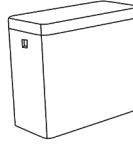

Water Tank
(Fill Valve and Flush Valve
Pre-installed)

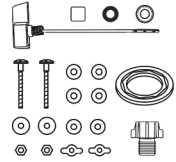

Water Tank
Accessories

Toilet Seat

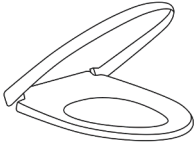

Toilet Seat & Lid

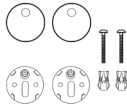

Toilet Seat
Accessories

Extension Pipe

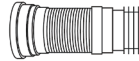

Flexible Extension
Pipe

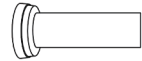

Rigid Extension
Pipe

PRODUCT DIMENSIONS (INCH)

Two-piece Toilet (MF000T05)

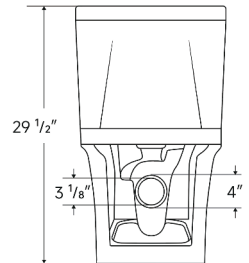
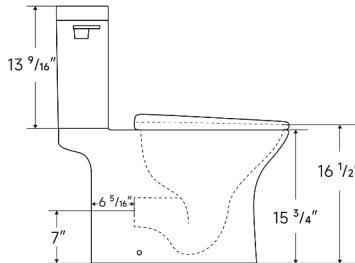
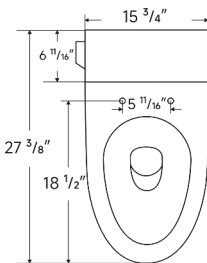

BEFORE INSTALLATION

1. Ensure that your bathroom has a drain exit and the cold water supply in place.
2. In order for your new toilet to fit correctly, please check the following dimensions:
 - ① The distance between the finished floor and the center of the wall drain exit, "Rough-in", must be about 7".
 - ② The PVC-U pipe of the wall drain exit should extend beyond the finished wall by about 0.4"-0.5".
 - ③ The water supply should be approximately 7.9"-9.8" to the left (when facing the bowl) of the toilet, and approximately 5.9"-7.9" above the finished floor. (Only applicable for the wall water supply.)
3. Water Supply: If your cold water line is through the wall, install an Angle Stop. If it runs through the floor, install a Straight Stop.

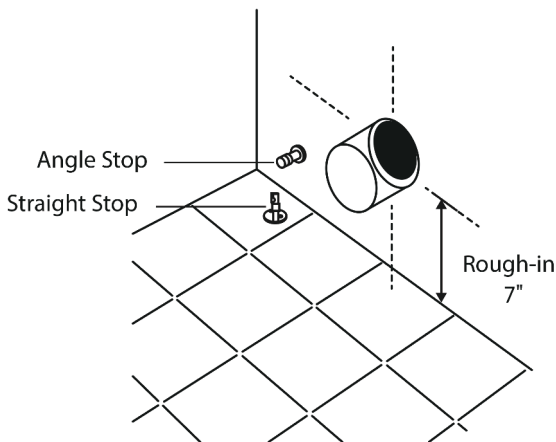

START INSTALLATION

Step 1: Old Toilet Removal (If Applicable)

- **Shut Off Water Supply:** Ensure the water supply valve is fully turned off.
- **Flush and Empty:** Depress the flush handle to drain water from the tank. Then manually remove any remaining water from the tank or bowl using a sponge or towel.
- **Disconnect the Supply Line:** Carefully detach the water supply line connected to the tank.
- **Detach the Toilet:** First, take off any decorative caps on the base of the toilet. Next, unscrew the nuts fastening the toilet to the floor.
- **Lift Away the Toilet:** With a firm grip, lift the toilet off its base and set it aside or dispose of it according to local regulations.
- **Prepare for New Installation:** Remove the old closet bolts from the toilet flange. Clean the base area thoroughly ensuring any residues like old wax or putty are removed.

Step 2: Measure And Record The Measurement

- Align the toilet's drain exit with the wall drain exit and place the toilet bowl on the ground.
- And record the following measurement:
 - ① Center distance from the ground.
 - ② Distance of the outlet from the wall.
 - ③ Diameter of the outlet.
 - ④ Distance of the mounting hole from the wall.

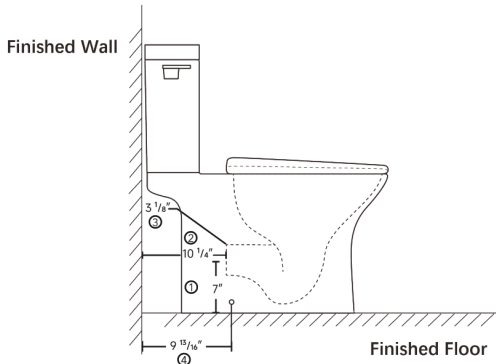

Note:

If the toilet's drain exit cannot be connected to the wall drain exit, please use an "Extension Pipe", and ensure that there is no leakage at the junction. You can also cut the "Extension Pipe" as needed.

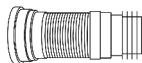

Flexible Extension Pipe

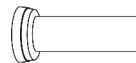

Rigid Extension Pipe

Step 3: Determine The Toilet Installation Location

- Place the toilet at the designated spot.
- Mark the points at the mounting holes, then remove the toilet.
- Drill the mounting holes at the marked points, then insert the expansion anchors.
- Place a washer onto each of the hexagon screws and fix the brackets to the floor.

Note:

Position the macerator pump at the intended spot before mounting the toilet if needed.

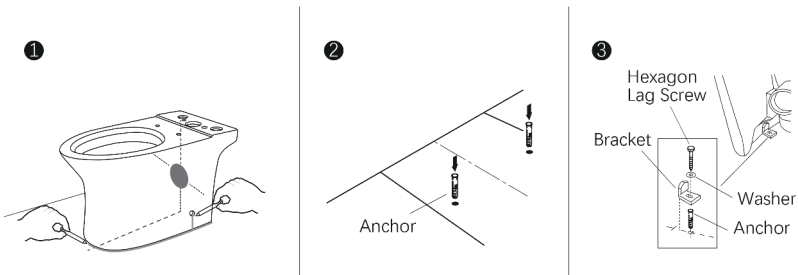

Step 4: Connect The Toilet To The Drain Outlet/Macerator Pump

- Attach one end of the rigid or flexible extension pipe to the toilet's outlet. Attach the other end of the pipe to A or B as shown below.

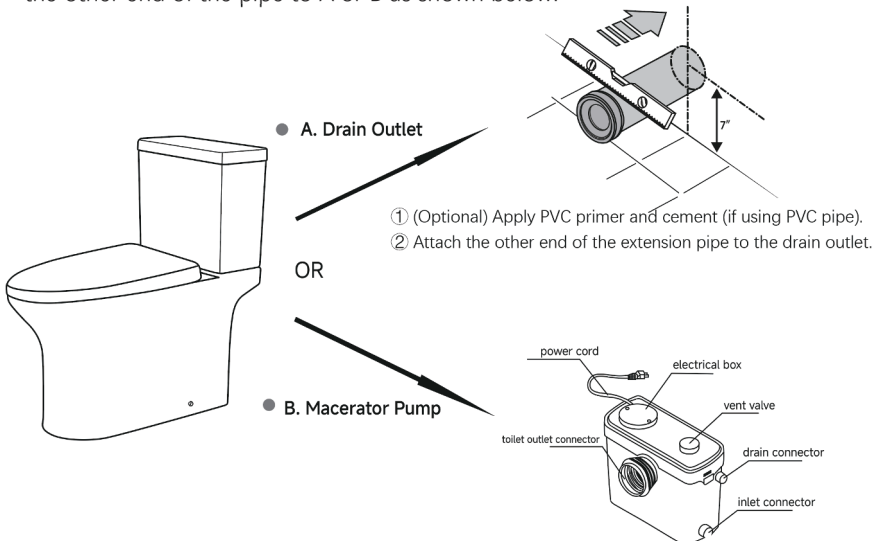

- ① Ensure the pump is properly positioned before connecting.
(Note: Place the clamp to the toilet outlet before connecting the EXTENSION PIPE.)
- ② Attach the other end of the extension pipe to the pump's inlet.
- ③ Secure the clamp and tighten it with a screwdriver.

- Install the plastic sleeves and use the screws to fix the toilet to the brackets. Attached the caps to the screw heads.

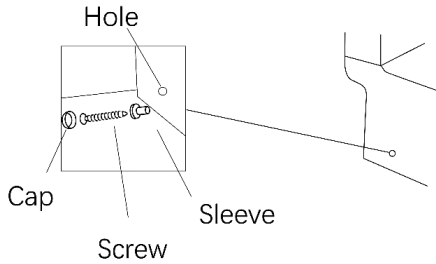

Step 5: Water Tank Assembly

- Position the tank-to-bowl gasket over the tank nut, ensuring there is no gap between the gasket and the tank.
- Insert the two tank bolts into the tank mounting holes. Lift the tank and guide the bolts to align the tank with the bowl.
- Place the washers and nuts in order. Alternately tighten the nuts to secure the tank to the toilet bowl.

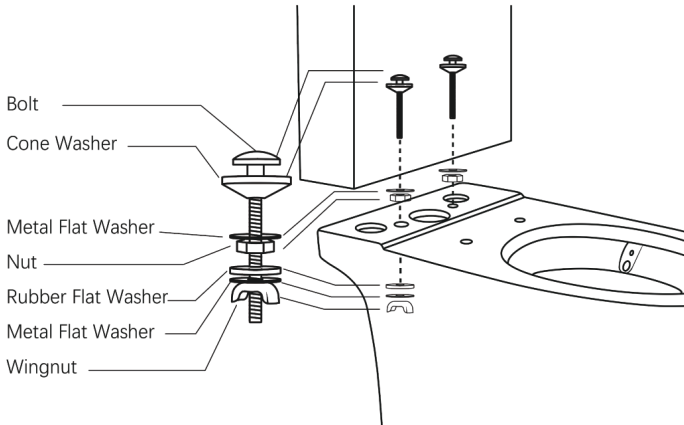

Step 6: Install Flush Lever

● Lever Assembly

1. Remove the positioning rubber, rubber washer and plastic nut from the lever arm.
2. Insert the lever arm and the positioning rubber through the square hole on the tank's left side. Adjust the rubber until it fits perfectly.
3. Secure the lever arm by tightening the rubber washer and plastic nut.

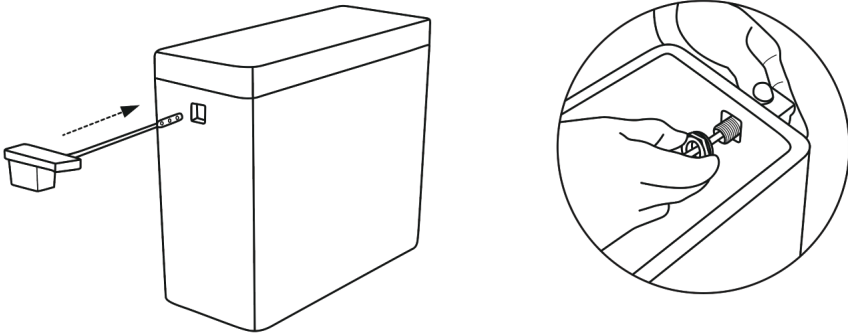

● Attach Flapper

1. Attach the chain from the flapper to the lever arm.
2. Ensure the chain length allows the flapper to fully raise when the lever is activated. Keep 5 or 6 extra chain links for potential future adjustments.

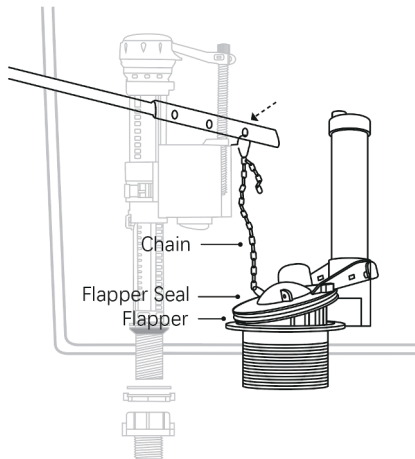

Step 7: Install The Water Supply Pipe And Test Flush

- Connect the water supply line. We offer a $\frac{7}{8}$ " to $\frac{1}{2}$ " fill valve pipe adapter. Use the adapter if needed.
- Tighten the supply line securely and turn on the water supply. Please Do Not Overtighten.

Note:

Avoid using plumber's putty, pipe dope, or any other sealants on the water supply connection to this tank. If a leak occurs after hand-tightening, consider replacing the supply line. If the leakage persists with a new supply line, it may be necessary to replace the fill valve.

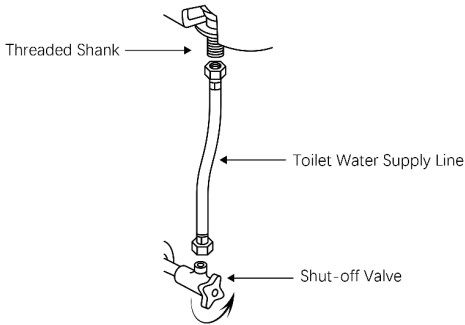

Water Supply Installation

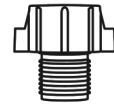

Adapter (Fits $\frac{1}{2}$ " toilet water supply line)

- Conduct a flushing test on the toilet, ensuring everything flows correctly and the pump activates as intended.
- After the flushing test, check all connection points for potential leaks. Tighten any loose connections further.

Step 8: Install The Toilet Seat

- Use the supplied seat bolts and washers, and install the seat per the seat instructions provided.

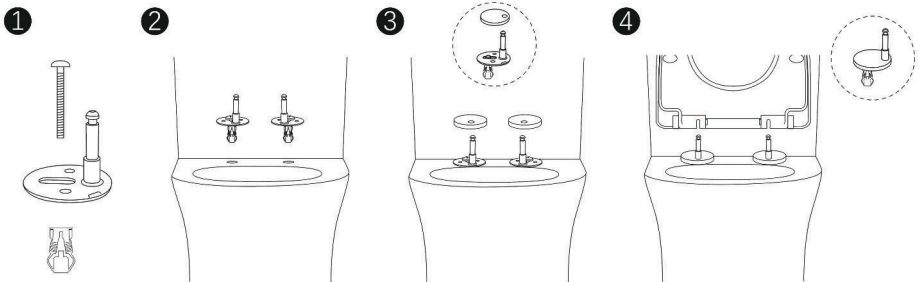

TROUBLESHOOTING GUIDE



When servicing or replacing any components, be sure the water supply is shut off and the toilet is flushed.

SYMPTOMS	PROBABLE CAUSES	REMEDIES
Does not flush	<ul style="list-style-type: none"> ● Water supply valve closed. ● Supply line blocked. ● Flush valve chain too loose or disconnected. 	<ul style="list-style-type: none"> ● Open valve and allow water to fill tank. ● Shut off water supply, disconnect supply line and inspect its accessories. Reassemble. ● Readjust chain length as required.
Poor flush	<ul style="list-style-type: none"> ● Tank water level too low. 	<ul style="list-style-type: none"> ● Adjust the fill valve to raise water level in tank. (Scan the QR code below to watch the steps from 00:49 for reference.) 
	<ul style="list-style-type: none"> ● Supply valve partly closed. 	<ul style="list-style-type: none"> ● Open supply valve fully. Be sure that proper supply tube size is used.
	<ul style="list-style-type: none"> ● Partially clogged trapway and/or drain pipe and/or vent. 	<ul style="list-style-type: none"> ● Remove obstruction. Consult a plumber if necessary.
	<ul style="list-style-type: none"> ● Supply pressure too low. 	<ul style="list-style-type: none"> ● Normal supply pressure must be at least 35 PSI.
Toilet leaks	<ul style="list-style-type: none"> ● Poor supply line connection. ● Poor bowl to tank/wall connection. 	<ul style="list-style-type: none"> ● Review Step 7 of installation procedure. ● Review Step 2 through 5 of installation procedure.
Toilet does not shut off	<ul style="list-style-type: none"> ● Flapper seal leaking or deformed. ● Flush valve chain too tight, holding flapper open. 	<ul style="list-style-type: none"> ● Clean debris from seal surface. Replace flapper seal as needed. ● Readjust chain length as needed. Review Step 6.

LIMITED WARRANTY COVERAGE

TWO YEAR LIMITED WARRANTY

MaceratingFlo products are crafted with superior materials and impeccable workmanship, offering our customers reliable and long-lasting products. If defects in materials or craftsmanship are detected under standard use within the first two years of installation, MaceratingFlo will either supply replacement parts at no charge or, if deemed necessary, replace the product or its parts, this warranty is exclusive to the original purchaser, and proof of purchase is mandatory for any claim.

We strongly advise all MaceratingFlo product installations be handled by a licensed, professional plumber or contractor. MaceratingFlo won't be held liable for damages or product malfunctions due to incorrect installation, misuse, or if a licensed professional isn't employed for the installation. We won't cover any associated installation or removal expenses.

This Warranty Will Be Voided If:

- The product's installation did not follow our recommendations.
- The product was relocated from its initial installation site.
- The product underwent any modifications from its original condition.
- The product suffered from neglect, misuse, chemical overuse, accidents, or any other damages.

MaceratingFlo does not imply that our products adhere to local building or plumbing codes. Consumers must ascertain local code compliance before and during installation. This warranty is strictly for the original purchaser and first consumer.

MaceratingFlo won't be held responsible for any consequential damages linked to the product's installation, replacement, return, or usage. This includes, but is not limited to, freight charges, labor, downtime, home damages, and other associated costs (e.g., professional services, investigations, audits, legal fees).

This MaceratingFlo warranty clearly delineates our liability. Items not specified in this warranty fall outside MaceratingFlo's responsibility. In states with variations concerning implied warranties, our compliance is ensured.

For any queries or concerns, feel free to reach out to us at

Email: cs@maceratingflo.com
Phone: (+1) 626-670-9903
Site: www.maceratingflo.com