



MT000T01

Two-Piece Toilet



FEATURES :

- Rear Discharge Two-Piece Toilet
- Chair-Height (16 1/2")
- Powerful Direct Flush
- Space-Efficient Round Bowl
- Left-Handed Flush Lever

SPECIFICATIONS :

- **N.W:** 72.8 LB
- **Dimension:** 26"L * 31 9/16"H * 16"W
- **Trap Type:** P-trap
- **Flush Type:** Direct Flush
- **Flush Rate:** 1.6GPF
- **Waste Outlet:** Wall
- **Seat Shape:** Round
- **Installation Type:** Floor Mounted
- **Quality Assurance:** 2-Year Warranty

	Bowl	Water Tank	Toilet Seat	Extension Pipes
Material	Ceramic	Ceramic	Polypropylene	Polypropylene
Color	White	White	White	White
Weight	39 LB	28.7 LB	2.8 LB	2.3 LB

PACKAGE INCLUDED :



Toilet Bowl

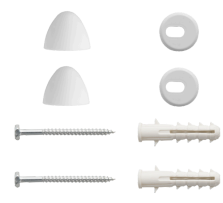

Floor Mounting Kit



Extension Pipes



Water Tank
(Water Fittings Pre-installed)



Water Tank Mounting Kit



Adapter



Tank-To-Bowl Gasket



Lever



Toilet Seat

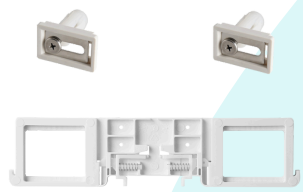

Seat Mounting Kit



DIMENSIONAL DIAGRAM :





**MACERATING
FLO**

Innovation For A Better Flow

DIMENSIONAL DIAGRAM :

EXTENSION PIPES:

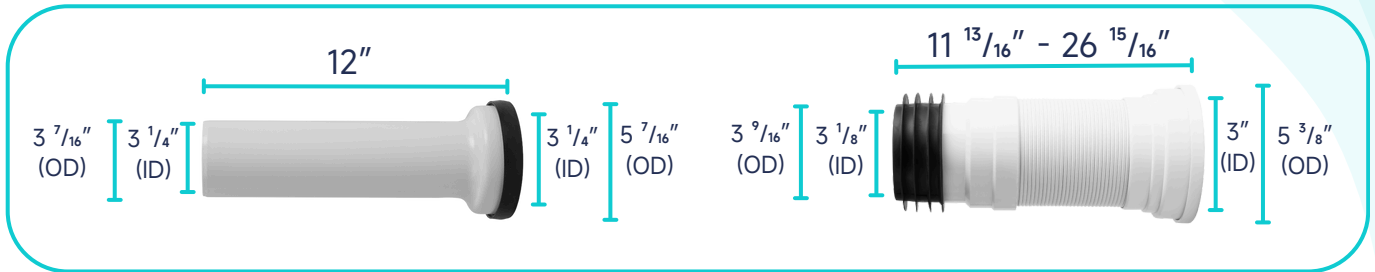

WATER TANK MOUNTING KIT:

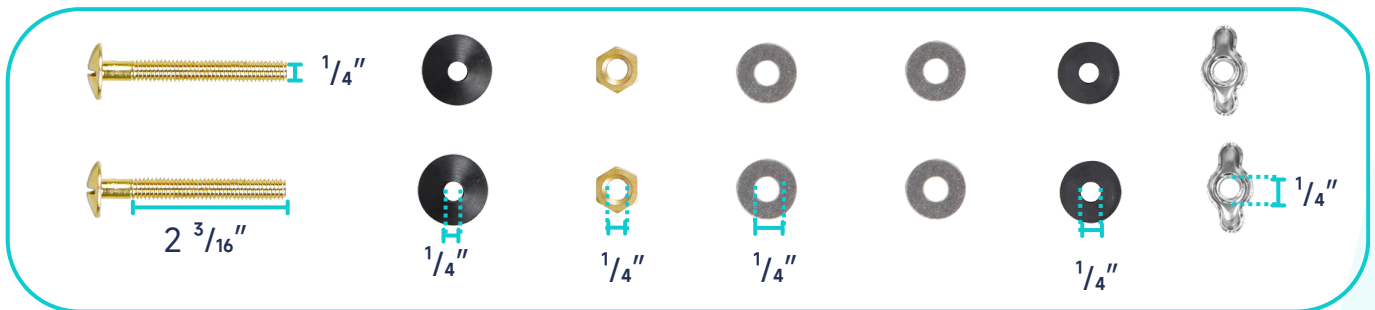

FLOOR MOUNTING KIT:

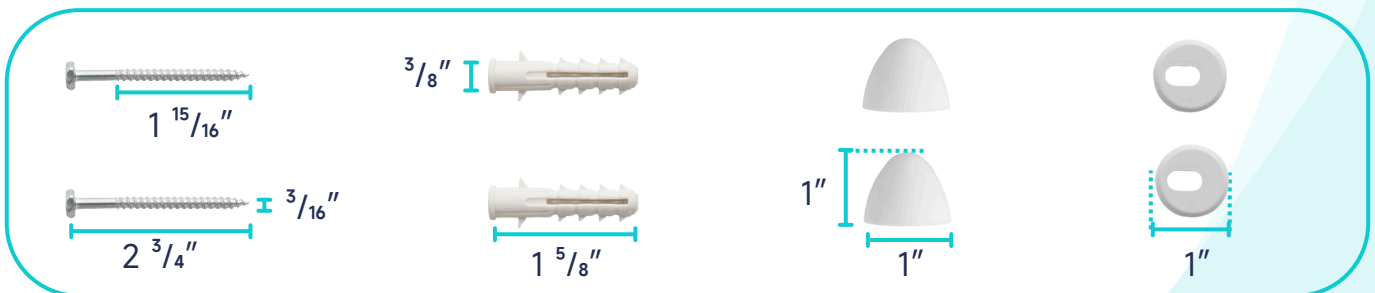

SEAT MOUNTING KIT:

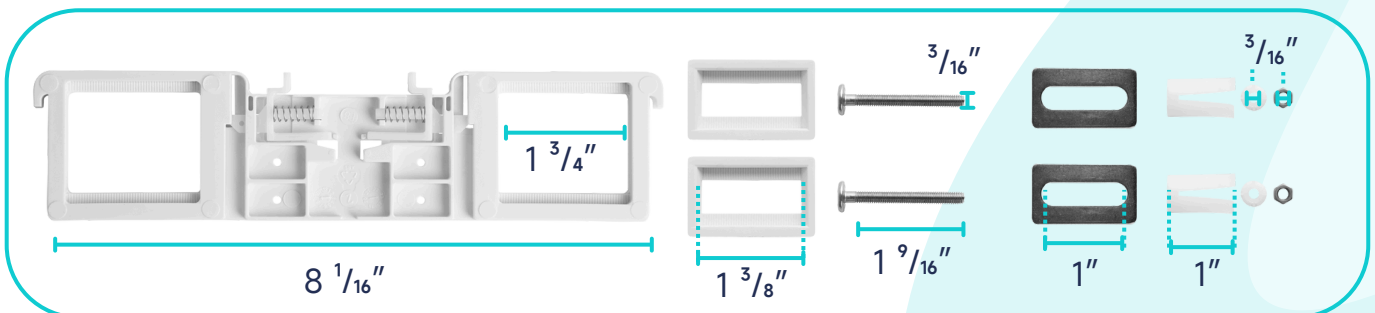

(+1) 626-670-9903

MaceratingFlo reserves the right to make revisions without notice to product specifications and dimensions. Product dimensions may differ due to manufacturing variations. Responsibility for using outdated or canceled specifications is not assumed. For the most current Specification Sheet, go to www.maceratingflo.com.



**MACERATING
FLO**

Innovation For A Better Flow

DIMENSIONAL DIAGRAM :

WATER TANK CONNECTION KIT:

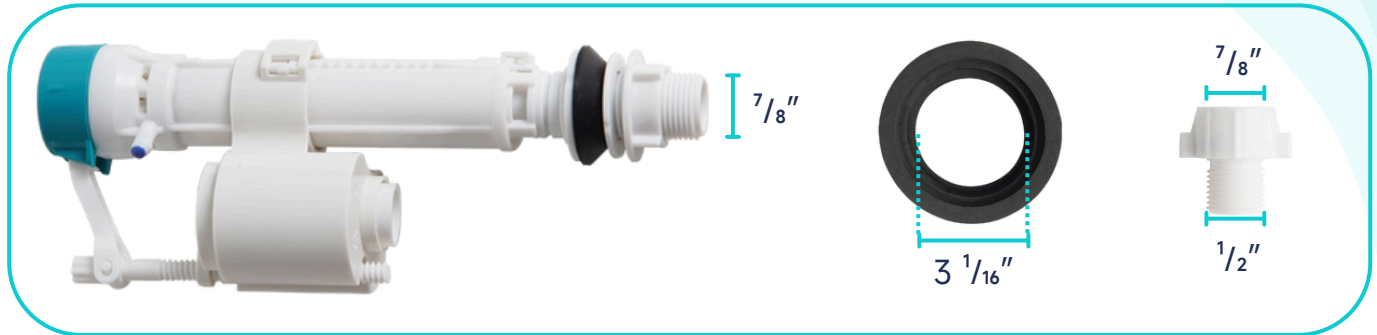

LEVER:

