



**MACERATING
FLO**

Innovation For A Better Flow

MF600T01 Macerating Toilet System



MACERATOR PUMP

FEATURES :

- 30 feet Max. Vertical Discharge
- 260 feet Max. Horizontal Discharge
- 3 Versatile Water Inlets
- 1 ½" Dual Use Vent Pipe
- Sewage Outlet With Built-in Check Valve

SPECIFICATIONS :

- **Dimension:** 17 ⁵/₁₆"L * 11 ⁷/₁₆"H * 7 ¹/₁₆"W
- **Power Factor:** 0.85
- **Insulation Class:** 155(F)
- **Speed:** 3450 RPM
- **Power Consumption:** 600 W
- **Supply Voltage:** 110V-60Hz
- **Sound Pressure Level:** <55 db(A)
- **Enclosure Class:** IP 55
- **Max. Flow:** 130L/min
- **Start Level:** 65mm
- **Stop Level:** 35mm
- **Cable Length:** 39 ³/₈"

TWO-PIECE TOILET

FEATURES :

- Rear Discharge Two-Piece Toilet
- Chair-Height (16 ½")
- Powerful Direct Flush
- Space-Efficient Round Bowl
- Left-Handed Flush Lever

SPECIFICATIONS :

- **N.W:** 72.8 LB
- **Dimension:** 26"L * 31 ⁹/₁₆"H * 16"W
- **Trap Type:** P-trap
- **Flush Type:** Direct Flush
- **Flush Rate:** 1.6GPF
- **Waste Outlet:** Wall
- **Seat Shape:** Round
- **Installation Type:** Floor Mounted
- **Quality Assurance:** 2-Year Warranty

(+1) 626-670-9903

MaceratingFlo reserves the right to make revisions without notice to product specifications and dimensions. Product dimensions may differ due to manufacturing variations. Responsibility for using outdated or canceled specifications is not assumed. For the most current Specification Sheet, go to www.maceratingflo.com.

PACKAGE INCLUDED :



Toilet Bowl

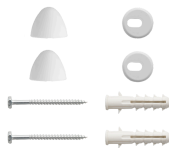

Floor Mounting Kit



Extension Pipes



Water Tank
(Water Fittings Pre-installed)



Water Tank
Mounting Kit



Adapter



Tank-To-Bowl Gasket



Lever



Toilet Seat

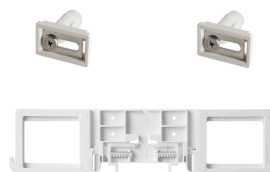

Seat Mounting Kit



Macerator Pump



Pump Fittings

	Pump	Bowl	Water Tank	Toilet Seat	Extension Pipes
Material	Stainless Steel, Polypropylene	Ceramic	Ceramic	Ceramic	Polypropylene
Color	White	White	White	White	White
Weight	14.3 LB	39 LB	28.7 LB	2.8 LB	2.3 LB

DIMENSIONAL DIAGRAM :

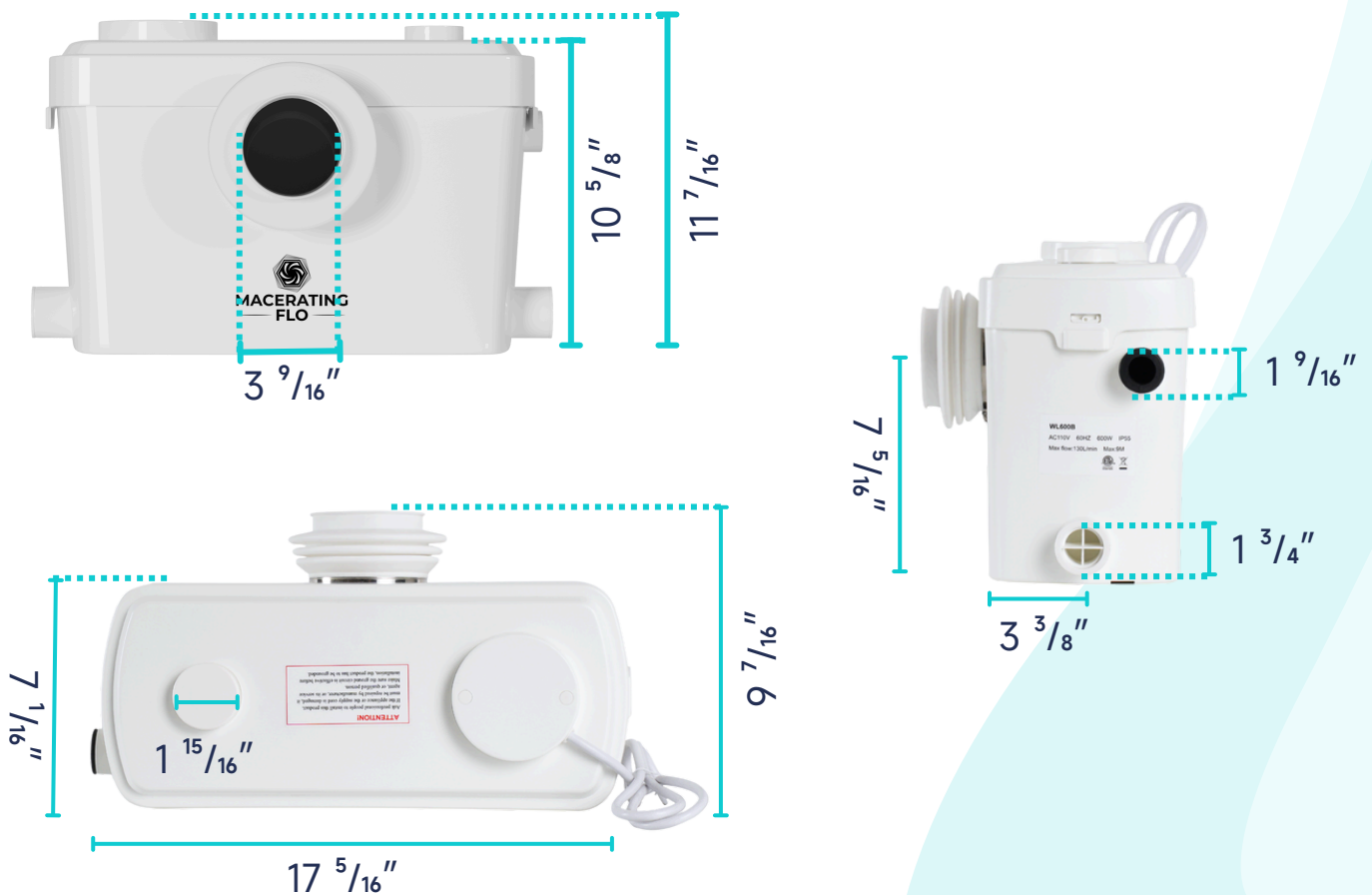

(+1) 626-670-9903

MaceratingFlo reserves the right to make revisions without notice to product specifications and dimensions. Product dimensions may differ due to manufacturing variations. Responsibility for using outdated or canceled specifications is not assumed. For the most current Specification Sheet, go to www.maceratingflo.com.



DIMENSIONAL DIAGRAM :





DIMENSIONAL DIAGRAM :

PUMP FITTINGS:

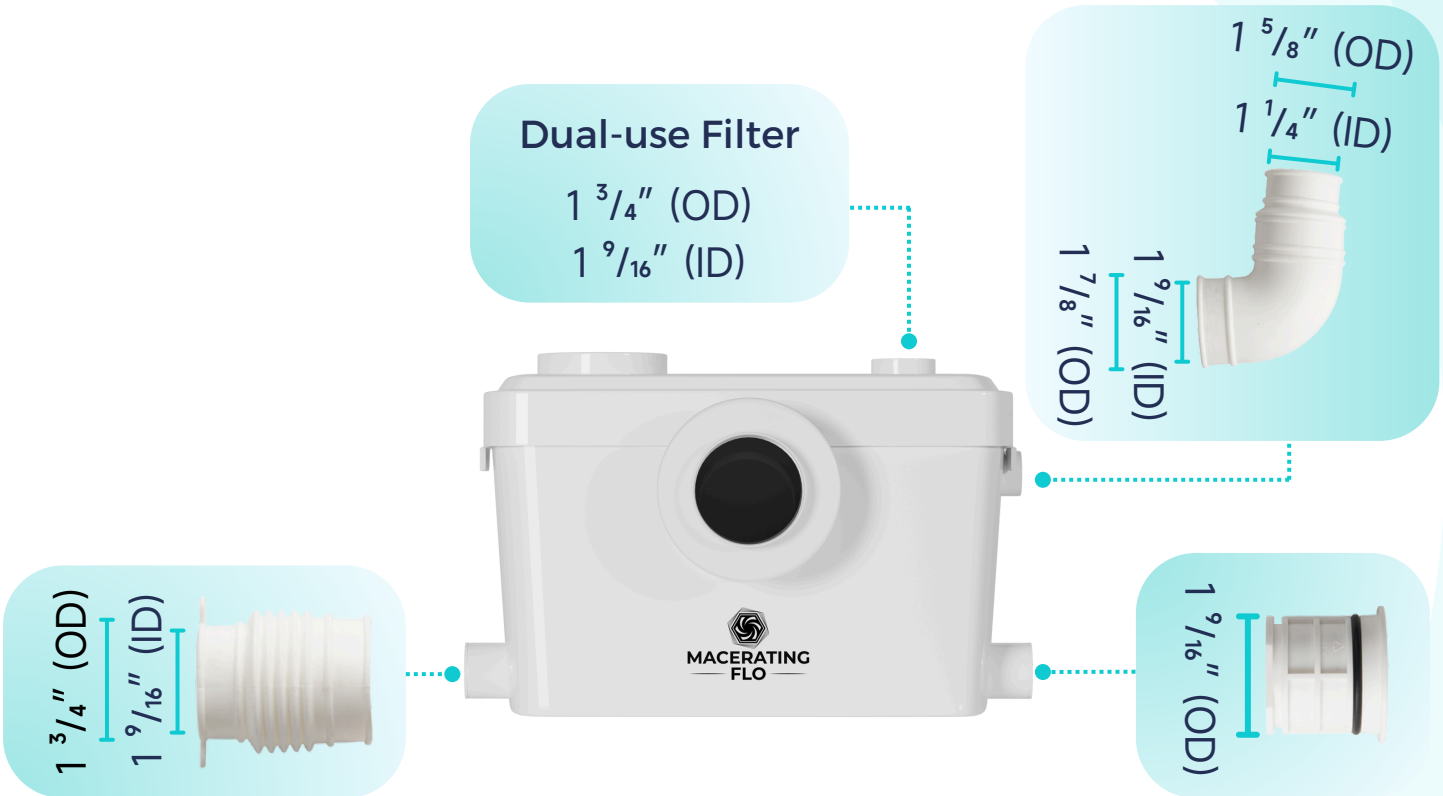

WATER TANK MOUNTING KIT:

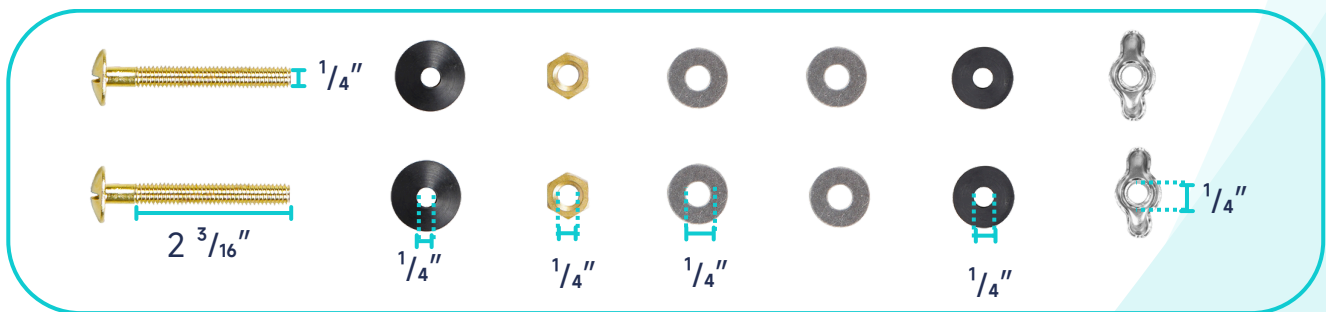

FLOOR MOUNTING KIT:

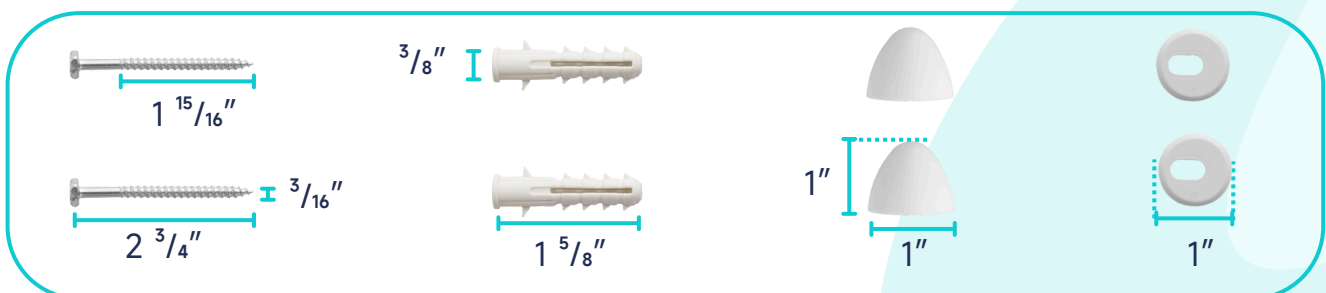



**MACERATING
FLO**

Innovation For A Better Flow

DIMENSIONAL DIAGRAM :

EXTENSION PIPES:

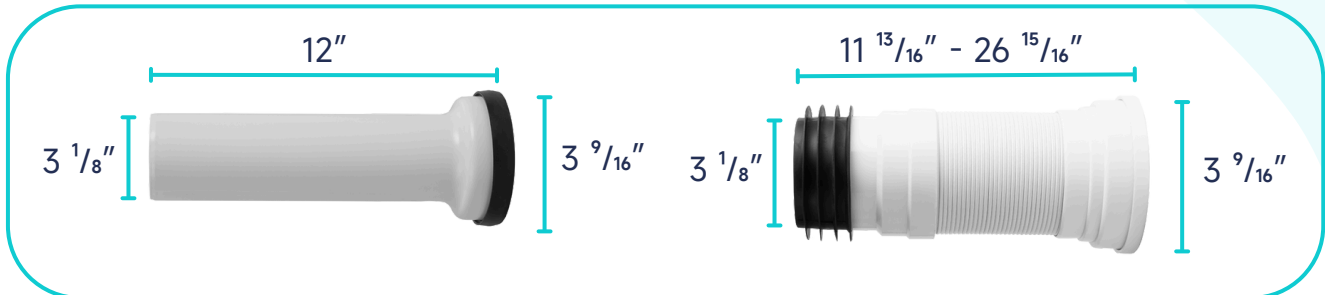

SEAT MOUNTING KIT:

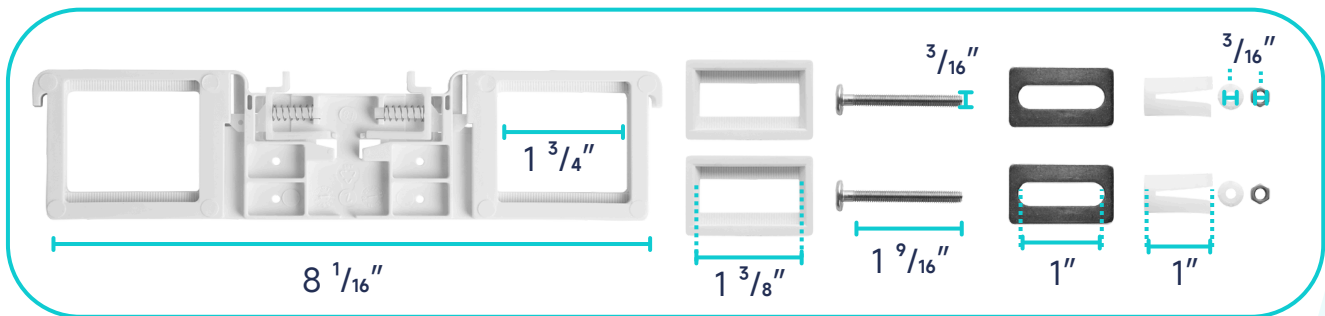

WATER TANK CONNECTION KIT:



LEVER:

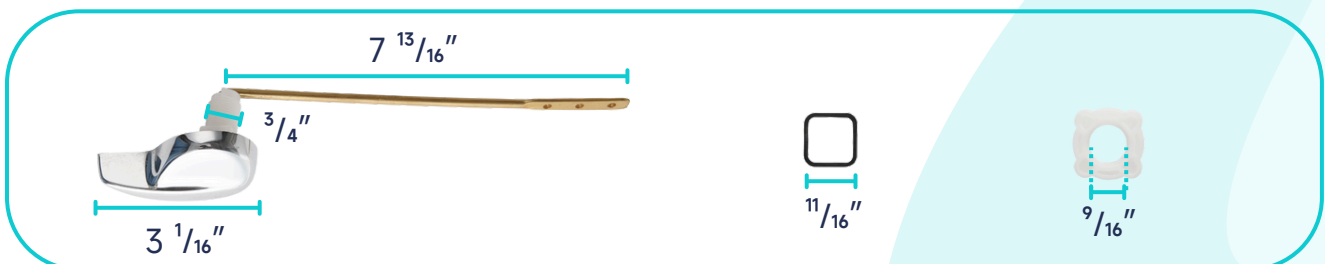

(+1) 626-670-9903

MaceratingFlo reserves the right to make revisions without notice to product specifications and dimensions. Product dimensions may differ due to manufacturing variations. Responsibility for using outdated or canceled specifications is not assumed. For the most current Specification Sheet, go to www.maceratingflo.com.